



Illustrative image. Actual product details may differ from the illustration.

GENERATOR POWER RATINGS

STANDBY POWER		PRIME POWER	
651 kVA	521 kW	591 kVA	kW
Rated voltage	400/230V		
Frequency	50 Hz		
Power factor Cos ϕ			
RPM: 1500 rpm	PHASES:	COOLING:	FUEL: Inline

Rated power PRP (Prime Power)

According to ISO 8528-1, PRP power defines the maximum power that the generating set can deliver continuously under variable electrical load, without limitation on the number of operating hours per year, provided that the operating conditions and service procedures specified by the manufacturer are observed. The average output power over a 24-hour operating period shall not exceed 70 % of the PRP value.

Emergency Standby Power ESP

According to ISO 8528-1, ESP power defines the maximum power available for emergency operation in the event of a utility power failure or during testing, limited to 200 operating hours per year. The average output power over a 24-hour operating period shall not exceed 70 % of the ESP value. Overload operation in this mode is not permitted.

POWER QUALITY AND PERFORMANCE

- Digital voltage regulation ± 0.25 %
- Three phase voltage sensing and control
- Total harmonic distortion THD below 2 %
- Fast load acceptance
- Performance class G2 in accordance with ISO 8528-5
- Suitable for manual and automatic operation

STANDARDS AND COMPLIANCE

- ISO 8528
- Machinery Directive 2006/42/EC
- Low Voltage Directive 2014/35/EU
- EMC Directive 2014/30/EU
- Noise Directive 2000/14/EC
- CE marking

- **Alternator insulation class H** • **Protection degree IP23** • **Compact design for transport and installation**
- **Forklift lifting capability from front and side**

ENGINE

Reliable power for continuous and standby operation

The diesel engine is the primary power source of the generating set. It converts chemical energy stored in fuel into mechanical energy, which is then transformed into electrical power by the alternator. The engine is designed for both continuous operation and standby applications, ensuring stable performance under variable load conditions. Depending on the configuration, the engine may feature an inline or V type cylinder arrangement and a naturally aspirated or turbocharged air intake system.

Combined with mechanical or electronic governing, this allows an optimal balance between efficiency, durability and fuel consumption across a wide power range.

The engine is suitable for industrial, commercial and infrastructure usage where reliability and predictable operation are required.

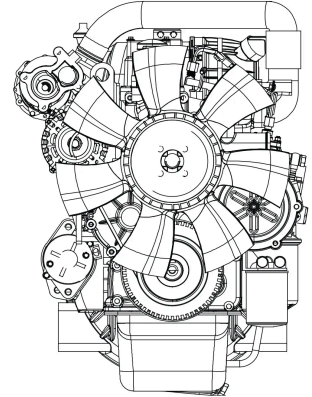

Engine specification

General data	
Model	-
Number of cylinders / configuration	
Displacement	
Bore / stroke	0
Compression ratio	0
Aspiration	Turbocharged & Aftercooler
Fuel system	Direct injection
Governor type	Mechanical
Cooling system	Water
Coolant capacity	
Speed / frequency	1500 rpm / 50 Hz
Oil capacity	
Speed governing	Electronic
Performance class	G2 / ISO 8528 5
Fuel type	Diesel EN 590
Engine electrical system	12 V / 24 V
Fuel consumption - Values refer to PRP operation in accordance with ISO 8528.	
100 % load	
75 % load	
50 % load	

APPLICATION NOTES

The engine is designed to operate at a constant speed required for power generation applications.

The governing system, depending on the engine configuration, ensures precise speed control and stable operation under varying load conditions.

The water cooled design and the selected air intake system provide effective thermal management, contributing to long service life and reduced maintenance requirements.

The engine can be combined with different alternators and control modules depending on the application requirements, power rating and system configuration.

ALTERNATOR

Stable electrical power for generator applications

The alternator converts mechanical energy supplied by the engine into electrical energy. It is designed for operation in generator sets used in continuous and standby power applications, ensuring stable voltage output under varying load conditions. Depending on the configuration, the alternator may be designed for three phase or single phase operation and can be equipped with different excitation and voltage regulation systems.

Brushless construction and automatic voltage regulation enable reliable performance, high efficiency and reduced maintenance requirements. The alternator is suitable for industrial, commercial and infrastructure applications where consistent power quality and long term reliability are required.



Alternator specification

General data	
Model	-
No. of phase	3
Power factor	0.8
No. of poles	
No. of leads	
Insulations class	H
Voltage regulation (steady state)	
Degree of protecon	IP 23
Excitation system	self-excited, AVR, Brushless
Frequency	50 Hz
Voltage output	400/230 VAC

APPLICATION NOTES

The alternator is designed to operate at a constant speed corresponding to the generator frequency.

The excitation system and automatic voltage regulation ensure stable voltage output and fast response to load changes.

Depending on the application, the alternator can be configured to operate with different engines, control modules and system layouts.

This allows flexibility in system design while maintaining compliance with applicable regulations and power quality requirements.

Technical description

Free standing power generator mounted on a robust steel base frame, suitable for a wide range of installation and operational configurations.

The unit is suitable for both continuous duty and standby operation in compliance with ISO 8528 requirements.

It ensures reliable performance under variable load conditions in industrial, commercial and infrastructure applications.

The acoustic pressure level LpA is measured at a distance of 7 m in accordance with applicable international measurement standards.

The system is equipped with a diesel engine coupled to a synchronous alternator. All components are selected and rated to operate within the performance parameters defined by the manufacturer, ensuring operational stability, safety and long service life.

GENERATING SET EQUIPMENT

Category, Elements	Category, Elements
ENGINE SYSTEM	ELECTRICAL PROTECTION SYSTEM
<ul style="list-style-type: none"> • Diesel engine, four stroke, liquid cooled • Fuel system with direct injection • Engine speed governor • Engine preheating system • Engine preheater • Electric starting system with battery set • Engine driven cooling fan • Radiator cooling system • Air intake filter • Oil filter • Fuel filter 	<ul style="list-style-type: none"> • Main circuit breaker of the generating set • Shunt trip coil of the generator breaker • Earthing point • Output terminal connection box
	FUEL SYSTEM
	<ul style="list-style-type: none"> • Integrated fuel tank within the base frame • Fuel retention system • Digital fuel level sensor
	STRUCTURAL FRAME AND INSTALLATIONS
ALTERNATOR SYSTEM	<ul style="list-style-type: none"> • Steel welded base frame, powder coated • Provisions for permanent installation • Vibration isolators reducing transmission of vibrations • Lifting and transport points • Transport handles and lifting points • Lifting lugs
<ul style="list-style-type: none"> • Synchronous alternator, brushless • Automatic voltage regulator AVR • Single bearing design • Insulation class H 	
CONTROL AND MONITORING SYSTEM	ENCLOSURE AND EXHAUST SYSTEM
<ul style="list-style-type: none"> • Digital generating set control system • Integrated control panel • Monitoring system of basic operating parameters • Engine and alternator protection systems • Emergency stop push button • Battery charging system • Electronic battery charger 	<ul style="list-style-type: none"> • Weather resistant sound attenuated enclosure • Acoustic and thermal insulation of hot components • Exhaust silencing system suitable for stationary operation • Exhaust silencer with vibration compensation • Exhaust outlet
	SERVICE AND OPERATION DESIGN
	<ul style="list-style-type: none"> • Design solutions facilitating service and operation • Easy access service doors • Protective grille for rotating and hot parts

Dimensions in enclosure



Length x Width x Height (mm)	
Generating set weight without fuel (kg)	5910 kg
Fuel tank capacity (L)	
Guaranteed sound power level (dB(A))	70 to 75 dB(A) at a distance of 7 metres

Sound attenuated enclosure specification

- Special design for noise level minimization
- Galvanized steel structure additionally protected with polyester powder coating
- Black painted locks and stainless steel hinges
- Inspection window for the control panel in lockable service doors
- Emergency stop button mounted on the external side of the enclosure
- Lifting, towing and fixing points on the main frame
- Radiator filling through a removable, tightly sealed rain cover with compression gasket

Operating guidelines

Service intervals of the generating set are defined in accordance with the recommendations of the engine manufacturer and the generating set manufacturer. Indicative values for standard operating conditions are presented below.

Fuel filter replacement	500 h or 1 year
Engine oil replacement	After first 100 h of operation, then every 500 h or 1 year
Oil filter replacement	After first 100 h of operation, then every 500 h or 1 year
Coolant replacement	1000 h or 2 years
Air filter replacement	500 h
Starter battery replacement	2 years
Electrical installation testing	In accordance with applicable regulations and PN-HD 60364-6

Note: actual service intervals may vary depending on operating conditions, load profile and engine manufacturer recommendations.

Warranty

The warranty period for the generating set depends on the operating mode and working conditions of the unit.

• Generating sets used as standby power supply:

60 months with a limit of **1000 operating hours**, provided that required periodic maintenance is performed

• Generating sets intended for continuous operation:

12 months with a limit of **1000 operating hours**

Detailed warranty conditions, including the scope of liability, service requirements and operational limitations, are defined in the warranty card, the technical and operational documentation of the generating set, or in accordance with the terms of the sales contract.

STANDARD CONTROLLER: DEIF SGC 420

ElectroQuell generating sets are supplied as standard with the DEIF SGC 420 control panel, which acts as the main control and measurement unit of the generating set. The controller executes start and stop sequences, supervises engine and alternator operation, performs electrical measurements and manages the full set of protection functions.

Operating modes

- Automatic
- Manual
- Remote start and stop
- Load test
- No load test
- Night power limitation mode

Measurements and functions

Monitoring of phase voltages, currents, frequency, active and reactive power, power quality, energy kWh, kVAh and kvarh. Start and alarm counters, charging alternator diagnostics and voltage measurement.

Protections

Complete engine and generator protections, including overload, overcurrent, loss of excitation, overheating, low oil level and auxiliary system failures.

Inputs and outputs

- 17 configurable analog inputs, including 5 resistive inputs, 4 to 20 mA inputs, 0 to 5 V inputs and one differential input
- 9 digital inputs of switch to ground type
- 7 configurable digital outputs for starter, stop solenoid, heater, alarm signalling and fuel system
- 4 current transformer inputs with secondary current of 5 A

Integration and communication

Modbus RS 485, CANbus with support for electronic engines, USB type B port for configuration and diagnostics. Integration capability with BMS and SCADA systems

Interface

Backlit LCD display with energy saving function and a clear HMI interface. Event log with capacity of up to 100 entries including date and operating time.

Controller power supply

12 or 24 V DC, operating range from 8 to 32 V DC, surge protection in accordance with ISO 7637-2.

Environmental conditions

- Operating temperature from minus 20 to 65 degrees Celsius
- Storage temperature from minus 30 to 75 degrees Celsius
- Humidity up to 95 percent RH
- Vibration resistance 2 G and shock resistance 15 g in accordance with IEC 60068
- Protection degree IP65 for the front panel
- Compliance with EMC standards IEC 61000-6 -2 and IEC 61000-6 -4

Dimensions

- Enclosure 233 x 173 x 38.5 mm
- Panel cutout 219 x 158 mm



★ BMS

★ SCADA

★ ModBus

★ SNMP

★ GSM /Ethernet

OPTIONAL CONTROL MODULES AND SYSTEM OPTIONS

Optional AMF controllers for single generator applications, selected based on site requirements, monitoring scope, and preferred communication interfaces.

ComAp AMF25



ComAp IntelliLite 4 AMF 25
Advanced AMF controller for single genset standby and prime power applications, with flexible I/O, monitoring, and remote communication options.

DEEPSEA 6120



Deep Sea Electronics DSE6120 MKIII
Auto Mains Failure controller with generator and mains monitoring, automatic start stop sequences, protection functions, and configurable inputs and outputs.

DEEPSEA 7320



Deep Sea Electronics DSE7320 MKII
AMF controller with expanded monitoring and communication capability, suitable where advanced functionality and wider integration options are required.

DEIF AGC 150



DEIF AGC 150
Alternative AMF controller option, typically chosen when a DEIF based control platform is preferred for the project.

CONTROLLERS FOR SYNCHRONISATION AND PARALLEL OPERATION

Controllers for synchronising, paralleling, and multi generator systems, used when load sharing, kW and kVAr control, dead bus synchronising, and coordinated start stop logic are required.

ComAp IntelliGen 200



ComAp IntelliGen 200
Controller family for synchronising and power management applications, supporting multi controller operation, PLC functionality, and remote connectivity depending on the selected variant.

DEEPSEA 8610



Deep Sea Electronics DSE8610
Auto Start Load Share controller for multi generator systems, designed for synchronisation, load sharing, and integrated governor and AVR control in parallel applications.

DEEPSEA 8660



Deep Sea Electronics DSE8660
Synchronising and paralleling controller option for projects that require this specific DSE platform for multi generator operation.

ATS ElectroQuell

Automatic transfer switching for standby power systems

The Automatic Transfer Switch ATS is the interface between the utility supply, the generator and the electrical distribution system. It continuously monitors the utility power parameters and initiates generator start when the utility supply drops out or moves outside the specified limits. Once the generator reaches stable operating conditions, the ATS transfers the load to backup power and supplies the main distribution board or a dedicated emergency panel, depending on the site configuration.

ATS units are selected based on the required current rating, switching topology and the connected load profile. Depending on the selected execution, ATS solutions may also provide monitoring functions for power status, operating mode and selected load related parameters.



ATS specification



Voltage	400/230 VAC
Model configuration	
ATS panel model	-
Capacity	
Dimensions Length x Width x Height (mm)	-
Frequency options (depending on configuration)	50 Hz or 60 Hz

APPLICATION NOTES

The ATS operates as part of the overall backup power architecture. The exact transfer logic and interlocks depend on the selected control module, site wiring concept and switching topology. For projects with defined requirements such as emergency circuits, selective load transfer or integration with building management systems, the ATS configuration is tailored to the installation concept.

OPTIONAL: AIR CIRCUIT BREAKER ACB

Intelligent low voltage protection for distribution & switching

An optional Air Circuit Breaker ACB can be specified for installations requiring higher current ratings, enhanced selectivity and integration with automation and monitoring systems. The ACB is suitable for low voltage distribution networks used to distribute power and protect circuits and supply equipment against overload, under voltage, short circuit and single phase ground fault, depending on the selected release unit and configuration.



Typical application range

- AC 50 Hz
- Rated voltage up to 660 V, 690 V depending on execution
- Rated current range 400 A to 6300 A

Protection functions depending on configuration

- Overload protection
- Under voltage protection
- Short circuit protection
- Ground fault protection

NOTE: All information in this document is provided for guidance purposes. Product details and component specifications may change as part of continuous product development or configuration updates. This document does not form part of any sales contract. All rights reserved (c) ElectroQuell 2026

Communication and integration

ACB versions with communication interfaces support remote status, remote signalling and integration with automation systems, depending on the selected option set.

Standards

- IEC 60947.2
- GB T 14048.2